



FAG

F11204

Flanged housing

Numer materiałowy Schaeffler:
0383828220000

Flanged housing for self-aligning ball bearing 112 with wide inner-ring, felt seal, grease lubrication

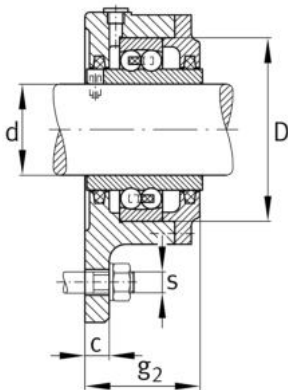
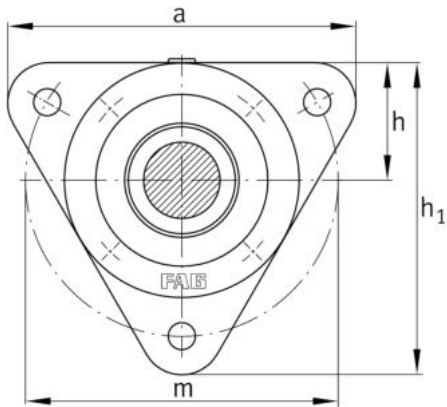

Main Dimensions & Performance Data

d	20 mm	Shaft diameter
a	105 mm	Flange width
g ₂	42 mm	Total width with cover
h ₁	92 mm	Height flange
	0,702 kg	Masa

Dimensions

	M10x1	Connection thread for lubrication
c	10 mm	Thickness of flange
D	47 mm	Outside diameter bearing
h	35 mm	Distance shaft axis
m	90 mm	Pitch circle diameter fixing holes
s	M10	Size of fixing screws