



FAG

F11206

Flanged housing

Numer materiałowy Schaeffler:
0383828490000

Flanged housing for self-aligning ball bearing 112 with wide inner-ring, felt seal, grease lubrication

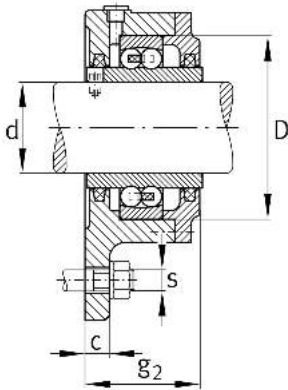
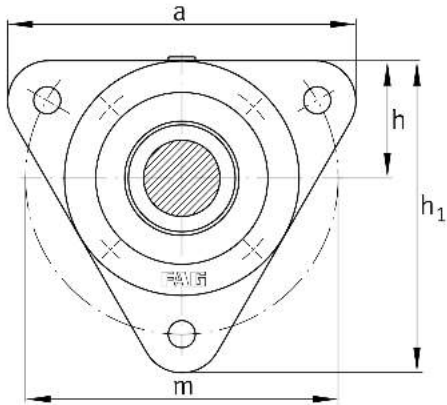

Main Dimensions & Performance Data

d	30 mm	Shaft diameter
a	130 mm	Flange width
g ₂	49 mm	Total width with cover
h ₁	117 mm	Height flange
	1,35 kg	Masa

Dimensions

	M10x1	Connection thread for lubrication
c	12 mm	Thickness of flange
D	62 mm	Outside diameter bearing
h	44 mm	Distance shaft axis
m	116 mm	Pitch circle diameter fixing holes
s	M10	Size of fixing screws