



FAG

F505-A-L

Flanged housing

Numer materiałowy Schaeffler:
0383828900000

Flanged housing for various bearing types,
with conical bore and clamping sleeve,
closed on one side

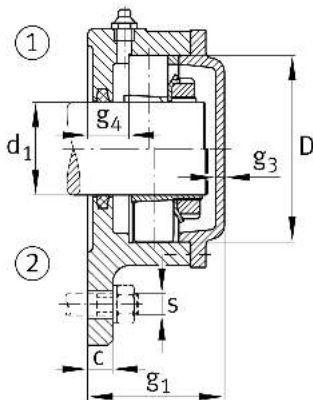
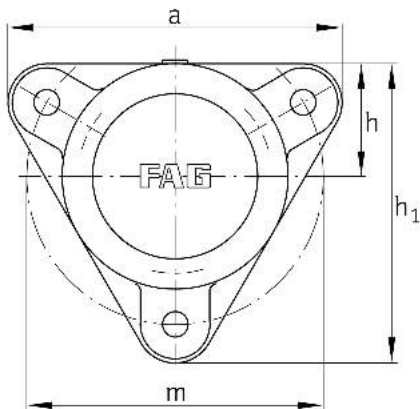

Main Dimensions & Performance Data

d_1	20 mm	Shaft diameter
a	110 mm	Flange width
h_1	100 mm	height flange
g_2	50 mm	total width with cover
	3	number of fastening holes
	1,2 kg	Masa

Dimensions

	M10x1	connection thread lubrication
c	10 mm	thickness of flange
D	52 mm	outside diameter bearing
g_4	16 mm	distance flange to bearing seat
h	38 mm	distance shaft axis
m	96 mm	pitch circle diameter fixing holes
s	M10	size of fixing screws